

## **Large LNG Trains: Technology Advances to Address Market Challenges**

Christopher M. Ott, William Schmidt,  
Joseph Wehrman, John Dally  
Air Products and Chemicals, Inc.

Within the Liquefied Natural Gas (LNG) marketplace, there is always a desire to reduce product cost, leading many project developers toward LNG projects with larger and larger single liquefaction train production capacities to achieve greater economies of scale. A variety of advancements are allowing LNG plant designers and equipment suppliers to meet this challenge. Advances in heat exchanger design and manufacturing capability, compressor driver and process cycle configurations, and compressor design and manufacturing capability all contribute to achieving larger single liquefaction train capacities.

### **Introduction**

For the last 5 to 10 years, the benchmark for a large LNG production train utilizing Air Products' AP-C3MR™ LNG Process with its SplitMR® Machinery Configuration has stood at approximately 5 mtpa. This capacity results from reaching the maximum referenced capabilities of three major components within a liquefaction train: 1) available driver power, 2) refrigerant compressor capacity and efficiency, and 3) coil wound heat exchanger capacity and efficiency. Advancement in any one component results in an incremental increase in LNG production capacity due to limitations in the other two components. However, recent developments in all three components, advancements in coil wound heat exchanger design and manufacturing capability, compressor driver options and configurations, and compressor aerodynamic design and manufacturing capability have made larger single train capacities utilizing a single Coil Wound Heat Exchanger (CWHE) a reality. Single liquefaction trains of 6 mtpa for the AP-C3MR™ LNG Process are currently being built.

### **Higher Production Requires More Refrigeration Power**

To support increased LNG production, more refrigeration power is required to liquefy the feed gas. Traditionally, the most effective ways to increase the total refrigeration power are to:

- 1) Improve the utilization of the available driver power
- 2) add more drivers, utilize drivers with higher available power, add helper motors

A good illustration of the first of these points is the Air Products SplitMR® Machinery Configuration that has been implemented and operating at many LNG facilities.

For many LNG plants in tropical or desert climates, approximately 1/3 of the refrigeration power is used for precooling natural gas and mixed refrigerant with propane (C3) and 2/3 of the refrigeration power is used for liquefaction of natural gas with a mixed refrigerant (MR). This works well when three identical

drivers are used, with the precooling power on one driver and the liquefaction power split among the remaining two drivers, with one driver on the Low Pressure MR Compressor (LPMR) and second driver on the Medium Pressure/High Pressure MR Compressor (MP/HPMR).

The power split for the different compressor casings is shown in Figure 1 below. However, the power split between precooling refrigeration and liquefaction refrigeration poses a challenge for fully utilizing the available power from two identical gas turbine drivers. To solve this issue, a portion of the liquefaction power can be shifted to the driver for the precooling refrigeration by strategically matching compressor bodies with drivers. The power split and driver position for the different compressor casings using the SplitMR<sup>®</sup> Machinery Configuration is shown in Figures 2 and 3 below. This process is being used in 11 liquefaction trains and has been in operation since 2003.

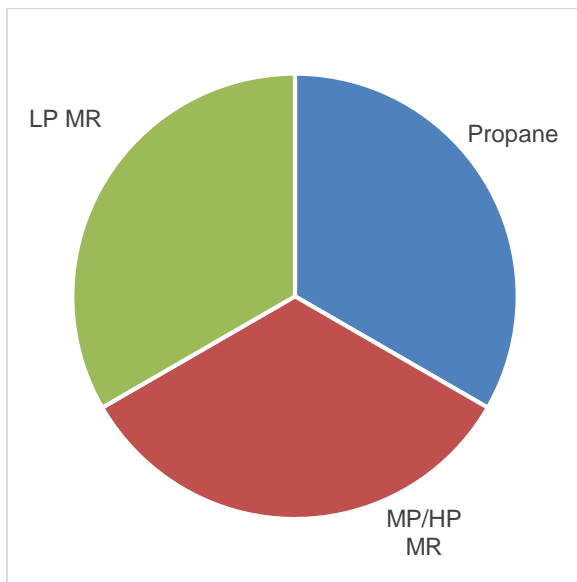

Figure 1: Traditional C3MR Power Split

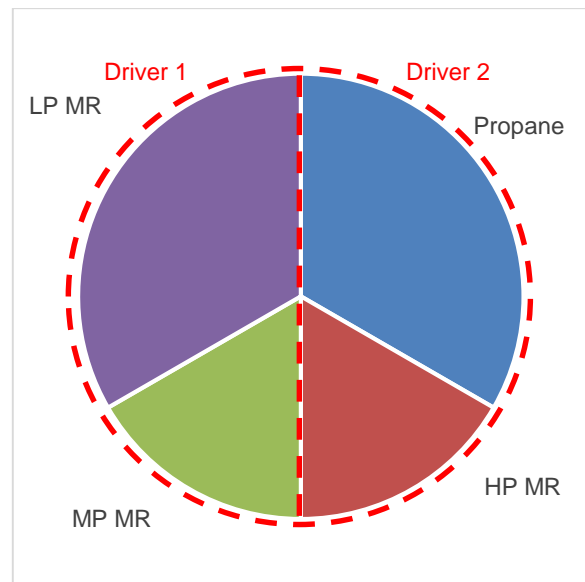

Figure 2: SplitMR<sup>®</sup> Power Split



Figure 3: SplitMR<sup>®</sup> Machinery Configuration

An example of adding more power by adding additional drivers is the Air Products' AP-X<sup>®</sup> LNG Process. With this process a third gas turbine driver is added to increase the available power and achieve a better split for the compressor duties. In the AP-X<sup>®</sup> LNG Process, heat in the subcooling section is rejected directly to atmosphere rather than cascaded to the (Mixed Refrigerant) MR or precooling sections. This helps to reduce refrigeration in the propane and MR compressors. The process design also maintained the compressor aerodynamic design and coil wound heat exchangers within the then-current references and manufacturing capabilities.

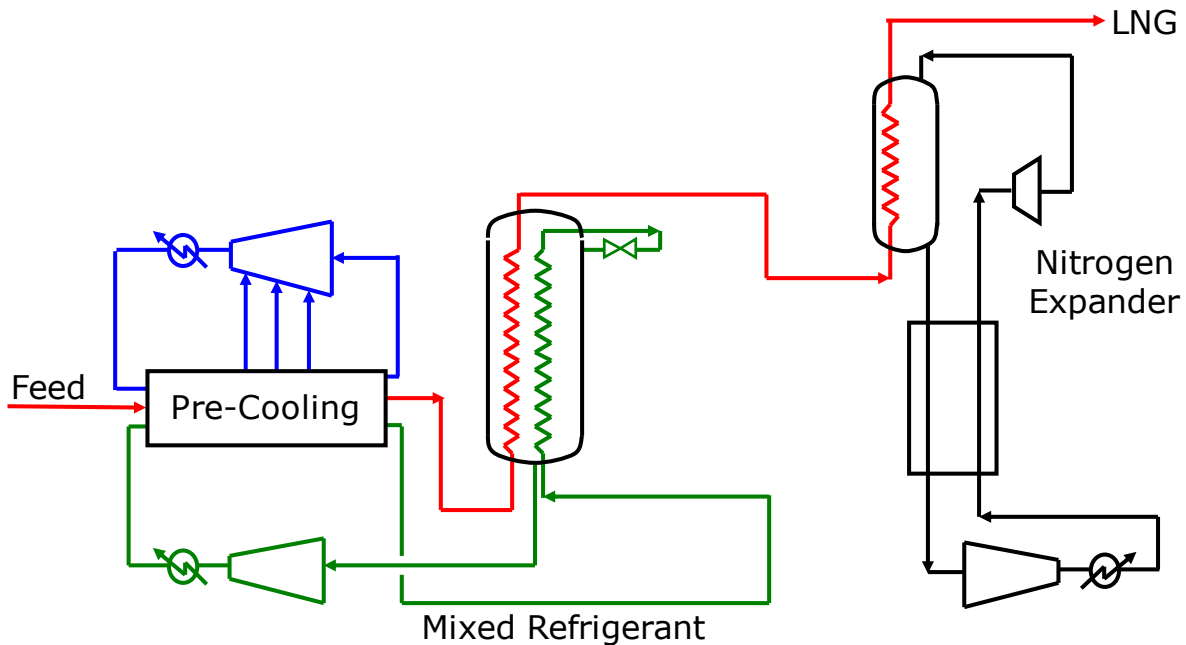

Figure 4: Air Products' AP-X® Process

Compared to the AP- C3MR™ LNG Process, the AP-X® LNG Process adds an additional driver for the nitrogen refrigeration compressor, which provides the subcooling refrigeration for the liquefaction process. With this additional refrigeration loop and driver, single train LNG production is increased to more than 7.8 mtpa.

The developments described above are two examples of producing more LNG by optimizing machinery configuration and providing more refrigeration power. Innovative solutions continue to be developed to increase the available power.

In addition to the well-referenced gas turbines that have been used in the LNG industry for many years, new large gas turbine options are becoming available that offer benefits such as improved fuel efficiency to improve LNG plant autoconsumption, multiple shafts that allow for easier starting and turndown, larger power outputs to produce more LNG, and finally, better shaft speed matches for refrigeration compressor loads that improve compressor aerodynamics and efficiency. The GE Frame 9E mechanical drive gas turbine has several references in the LNG industry. In addition, gas turbines such as the GE LMS100, the Mitsubishi Hitachi H110, and the Siemens SGT5-2000E (V94.2) are referenced in the power generation industry and are currently being considered for mechanical drives for LNG projects. Some of these larger gas turbines operate at a lower speed instead of the higher speed typical of smaller gas turbines, which provides an efficiency and aerodynamic benefit to larger compressors.

Instead of switching to larger gas turbine drivers, other methods are being used to increase refrigeration power to increase LNG production using well-referenced drivers in the LNG industry. As an example, the GE Frame 7E mechanical drive gas turbine has seen a number of evolutionary improvements leading to increased available power. Helper motor sizes as large as 25 MW, along with temperate and arctic LNG

plant locations, have further increased the available power in drivers that are well-referenced in the LNG industry, leading to additional increases in LNG production.

Aeroderivative gas turbines are also becoming widely accepted in the LNG industry as mechanical drives. Aeroderivative gas turbines are gas turbines developed from aircraft jet engines. As a result, these gas turbines have some unique features compared to industrial gas turbines. Aircraft engines need to be lightweight, fuel efficient, easily swapped in and out of service, and possess the ability to quickly ramp the power up and down. These same features have found their way into aeroderivative gas turbines used for mechanical or compressor drives. Table 1 shows some features of aeroderivative gas turbines compared to more traditional industrial gas turbines.

	Industrial Gas Turbine	Aeroderivative Gas Turbine
Efficiency	Lower	Higher
LNG references	Many	Limited but growing
Starter Motor	Required	Not Required
Ambient Temperature Impact on Power	Smaller	Larger
Speed Range	Narrower	Wider
Full Suction Pressure Restart	No	Yes
Single Driver Power Output	Large	Small

Table 1: Industrial Gas Turbine vs. Aeroderivative Gas Turbine

There has been a lot of information published about the use of aeroderivative gas turbines in LNG processes. One important factor in considering an aeroderivative gas turbine as a mechanical driver for a refrigeration compressor is that the power available from a single aeroderivative gas turbine is relatively lower than that from many industrial gas turbines. Therefore, to achieve 4 to 6 mtpa, several aeroderivative drivers are needed to drive parallel compressors as compared to the traditional, well-proven two Frame 7 arrangement. Figure 6 shows various gas turbine drivers that have been used in the LNG industry or are currently being considered for future projects. The estimated liquefaction train capacity using the SplitMR<sup>®</sup> Machinery Configuration is shown as a function of the available power for each driver. Actual liquefaction train capacity will depend on project specifics such as process configuration, feed gas composition and conditions, and plant location.

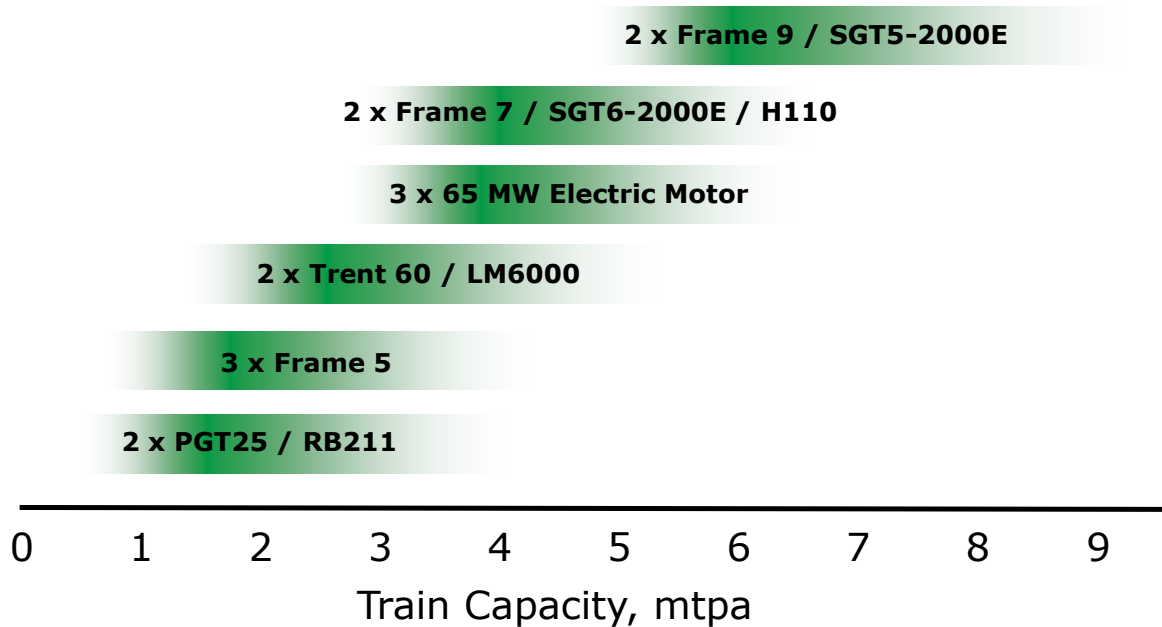

Figure 5: Liquefaction Train Capacity for Typical Compressor Drivers

As shown in the figure above, another possibility for higher power is the use of electric motors. Large electric motors have been used in LNG facilities and are being considered more often, especially where there is an established and robust power grid. Electric motors can be built in virtually any power rating, with 65 MW being the largest motors demonstrated in LNG service to date. A facility with larger motors is currently in manufacturing and construction. Variable speed drive systems (VSDS), such as Variable Frequency Drives (VFDs) or variable speed hydraulic couplings, allow the refrigerant compressors to be started under load. With a VSDS, the compressor speed can also be adjusted for efficient turndown operation. Electric motor output power is not affected by ambient temperature and the efficiency of electric motors is relatively high. The combination of high design output power of a motor with the possibility of using 3 or more motors as part of the refrigeration system, allows for a higher LNG production in a single liquefaction train. Figure 6 illustrates an exemplary system with 3 x 65 MW electric motors that can be used to produce 4 to 6 mtpa.



Figure 6: Electric Motor Driver Arrangement

### New Driver Arrangements, Improved Compressor Aerodynamics

Adding more refrigeration power increases LNG production, provided that the refrigeration compressors can utilize all the available power. As driver power increases, the required refrigerant compressors'

aerodynamics may exceed well-referenced refrigerant compressor designs. Two key compressors design parameters are:

- 1) Tip (or Peripheral) Mach number: ratio of the impeller tip velocity to the sonic velocity
- 2) Inlet flow coefficient: dimensionless parameter that indicates the general impeller geometry

Figure 7 below summarizes the general capabilities of LNG compressors, showing the well-referenced operating envelope for LNG refrigerant compressors. In a C3MR process, the operating conditions for the MR and Propane compressors typically fall within the well-referenced operating envelope (the blue shaded region) for a 4 to 5 mtpa LNG plant with conventional machinery arrangements. As LNG production increases beyond 5 mtpa, the compressor design operating points tend to move beyond the well-reference operating envelope (into the orange shaded region).

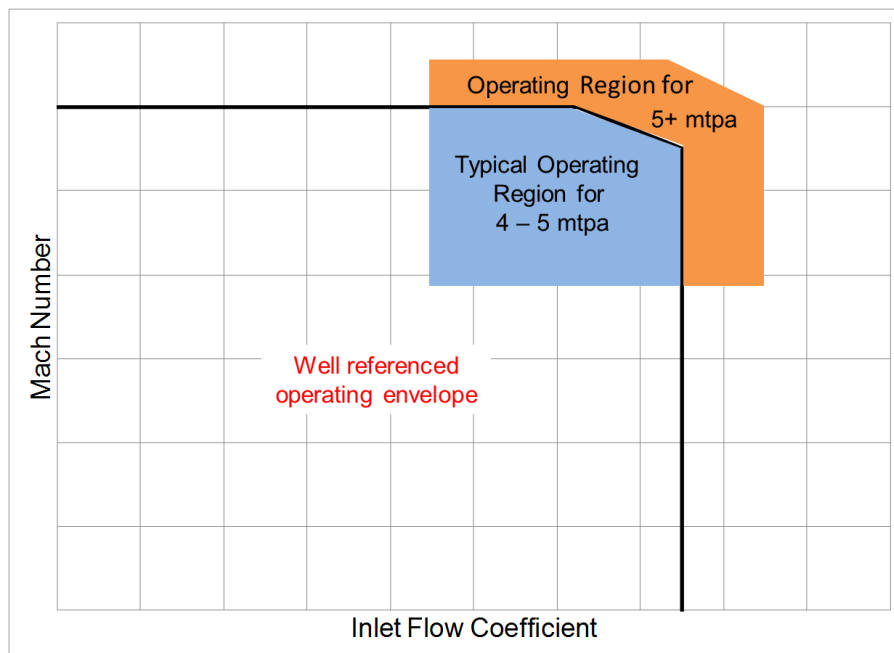

Figure 7: Compressor Operating Envelope

Many projects are considering compressor designs that lie within the orange region, with high Mach number and high flow coefficient impellers. Whether these designs are acceptable for a given project then becomes a discussion point with the owner/operators during the design phase. Operating references are always important in regards to the overall project risk management. Operating conditions that are acceptable by one project team may not be acceptable for a different project.

One way to affect compressor aerodynamics is by adjusting the compressor speed. Optimum impeller designs for larger volumetric flows have lower speeds and larger impellers. Note that all impellers within a single compressor casing and all compressors on a single driver must operate at the same speed. There is an optimum speed and diameter for each impeller and the compressor supplier must

make trade-offs in the compressor design to optimize the entire compression system. This can affect the LNG plant design in various ways. For smaller plants, a gearbox is sometimes needed to increase the compressor speeds. With larger plants with larger gas turbines, a slower speed is needed, and often a 3,000 rpm drive speed is optimal.

Using parallel compressors reduces the flow through a single compressor, while maintaining the same total refrigerant flow to the liquefaction unit. This typically places the compressor within the well-referenced envelope of Figure 7. As an added benefit, parallel compressors offer higher LNG plant availability. With parallel compression strings, the LNG plant can operate at reduced throughput when one compressor string is offline, meaning the LNG plant spends more time producing LNG throughout the year. Parallel compressor strings also provide higher turndown capability of the compressors without having to recycle as one compressor string can be shut down during turndown operation. Parallel compression can also automatically shift loads between compressors on the same shaft.

Two examples of using parallel compression to produce 5 to 6 mtpa are shown below. First, the smaller single unit power output of aeroderivative gas turbines fits very well to parallel refrigerant compressors. For example, using 4 aeroderivative gas turbines such as a GE LM6000 or Siemens Trent 60 in a parallel SplitMR® Machinery Configuration, shown below, can provide enough power to produce approximately 5 to 6 mtpa of LNG.

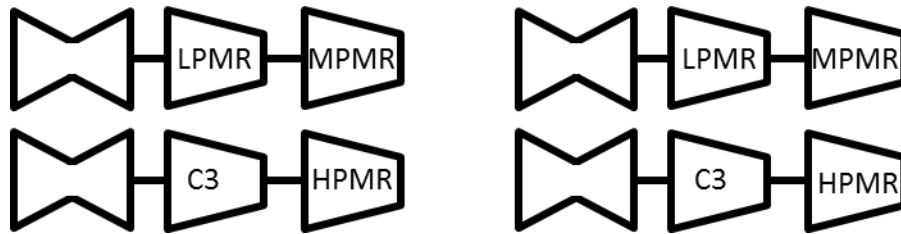

Figure 8: Parallel SplitMR® Machinery Configuration

A second example uses parallel large industrial gas turbines to improve the aerodynamic conditions in the refrigerant compressors. For example, two GE Frame 7Es with helper motors, two Siemens SGT6-2000E or two Mitsubishi/Hitachi H110 mechanical drive gas turbines can provide enough refrigeration to produce approximately 6 mtpa of LNG while staying within the referenced compressor design envelope in Figure 7.



Figure 9: 50% Parallel AP-C3MR™ LNG Process

An advantage of the compressor arrangement shown in Figure 9 is that as the power split between propane for precooling and MR for liquefaction changes as a result of changing process conditions, such as ambient temperature, load is automatically shifted between the MR and propane compressors to

ensure the driver power is fully utilized. This is particularly useful in colder climates where the seasonal variation of ambient air temperature is large.

### **Increased Coil Wound Heat Exchanger (CWHE) Manufacturing Capability**

Air Products has manufactured LNG CWHEs at its Wilkes-Barre, Pennsylvania, USA facility for over 45 years. In July 2012, Air Products shipped its 100th CWHE and continues to build on that number. To meet the increasing demand for CWHEs, Air Products expanded its manufacturing capacity by constructing a second manufacturing facility in Manatee County, Florida, USA. This location's ready access to port services will facilitate global shipping of this very large equipment and also allow Air Products to manufacture even larger LNG heat exchangers demanded by the market. The new location is within 1 kilometer of a deep water port, which eliminates shipping limitations between the manufacturing facility and the port.

This new manufacturing facility has been constructed with the capabilities to manufacture coil wound heat exchangers capable of producing over 6 mtpa of LNG. This new facility will allow Air Products to meet customer demands for larger LNG trains while continuing to ensure the high quality and reliability of its CWHEs.

### **Advances and Enhancements to Coil Wound Heat Exchanger Design**

In addition to expanded manufacturing capacity resulting from a second production facility, Air Products continues to innovate and enhance the technical capabilities of the CWHE.

These innovations include:

- 1) stainless steel pressure vessel shells to facilitate large exchangers and higher design pressures
- 2) advances in internal designs, to allow for higher feed pressures and improved efficiency
- 3) innovative modularization designs and techniques to facilitate customers' construction schedule

The use of stainless steel pressure vessels with traditional aluminum internals was initially developed to meet the higher shellside design pressure required for the nitrogen subcooling CWHEs in the AP-X® LNG Process, and has further refined this technology to support the floating LNG industry. Stainless steel pressure vessels are better suited to handle the harsh marine environments and fatigue conditions characteristic of floating LNG facilities. In addition, stainless steel pressure vessels allow for larger diameter exchangers since the wall thickness is less than that for aluminum, improving manufacturability for exchanger sizes for which aluminum is not practical. By integrating stainless steel shells with aluminum internals, exchanger size can increase substantially while still maintaining the superior heat transfer characteristics of aluminum internals. Also, by continuing to use aluminum internals, exchanger weight is minimized. Through the successful implementation of this initiative, Air Products has demonstrated that it can design and fabricate CWHEs that allow for differences in thermal expansion and contraction between the dissimilar metals while simultaneously maintaining the critical features of efficiency, robustness, and reliability



Air Products has expanded the capabilities of the aluminum internals to handle tubeside design pressures in excess of 100 barg as well as higher shellside flowrates associated with larger capacity heat exchangers. Higher tubeside and shellside design pressures allow for increased LNG production capacity and the application of process cycles with higher shellside operating pressures such as AP-DMR™ LNG Process and AP-N™ LNG Process. Higher shellside design pressures also tolerate a higher system settle out pressure which can reduce or even eliminate refrigerant losses due to heat leak when the plant is shutdown.

Air Products developed designs and strategies for modularization and pre-fabrication. This has been done to support not only floating LNG, but also land based LNG plants located where a stick-built construction philosophy is cost prohibitive such as in arctic and remote locations. These applications all have unique requirements, but share the common need to place the normally free standing CWHE into a modular structure and a reduced footprint. To support this, Air Products is capable of designing the CWHE to handle potential blast scenarios that must be considered with such reduced footprints and the reduction in open space between process equipment.

#### **Improved Coil Wound Heat Exchanger Performance**

Larger single liquefaction train capacities require larger CWHEs that must handle increased feed rates and refrigerant flows. For a CWHE, an increase in the diameter of the CWHE results in an exponential increase in capacity as flow and heat transfer area in the CWHE increase with the square of the CWHE diameter. This allows for large increases in LNG production with small increases in CWHE diameter. To provide higher LNG production, the CWHE must also accommodate increased refrigeration duties. This can be accomplished by simply increasing the area of the heat exchanger, resulting in a proportionally larger heat exchanger. Alternatively, the heat transfer performance of the heat exchanger can also be improved to handle the larger refrigeration duty by further optimizing the design of the tube bundle. In Figure 10, the trend of single liquefaction train capacity is shown compared to CWHE heat transfer area.

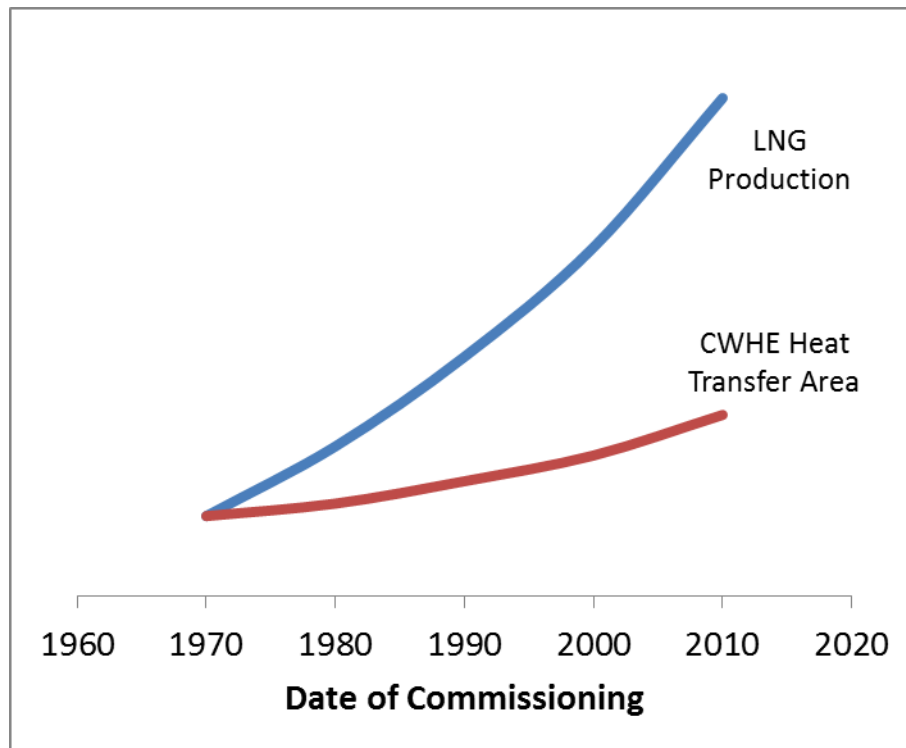

Figure 10: LNG Production and CWHE Size

Proportionally increasing exchanger area with LNG production would result in parallel curves. However, the curves show that the performance of CWHEs has improved over time. This improved performance is the result of optimizing the exchanger designs to handle increased refrigerant flows and provide more efficient refrigerant distribution. Air Products continues to enhance its CWHE designs to handle the much larger refrigerant flows required for larger single liquefaction train capacities.

### Conclusion

Larger CWHEs, combined with increased refrigerant compressor and driver capabilities are paving the way for large, highly efficient liquefaction trains. These liquefaction trains meet the key criteria for modern designs by being highly efficient, utilizing all of the installed driver power and minimizing technology step-outs and risks by using proven equipment such as staying within current refrigeration compressor aerodynamic limits. . These advancements are being applied to liquefaction trains currently in design and under construction with single liquefaction train sizes over 6 mtpa.